

SAMUEL HEATH

Product Number: V218-IS

Description: 3 Hole wall mounted filler - rough

Standards

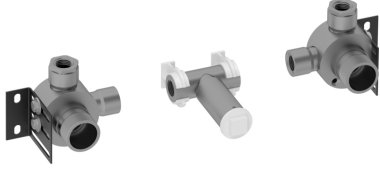

Specification Drawing

TRIM	DIMENSION 'A' RANGE
V117	65.50 TO 90.00
V147	55.00 TO 92.00
V120	66.70 TO 92.00
V217 & V247	63.00 TO 75.00
V617	62.00 TO 70.00
V647	62.00 TO 74.00
V817 & V847	64.00 TO 79.00

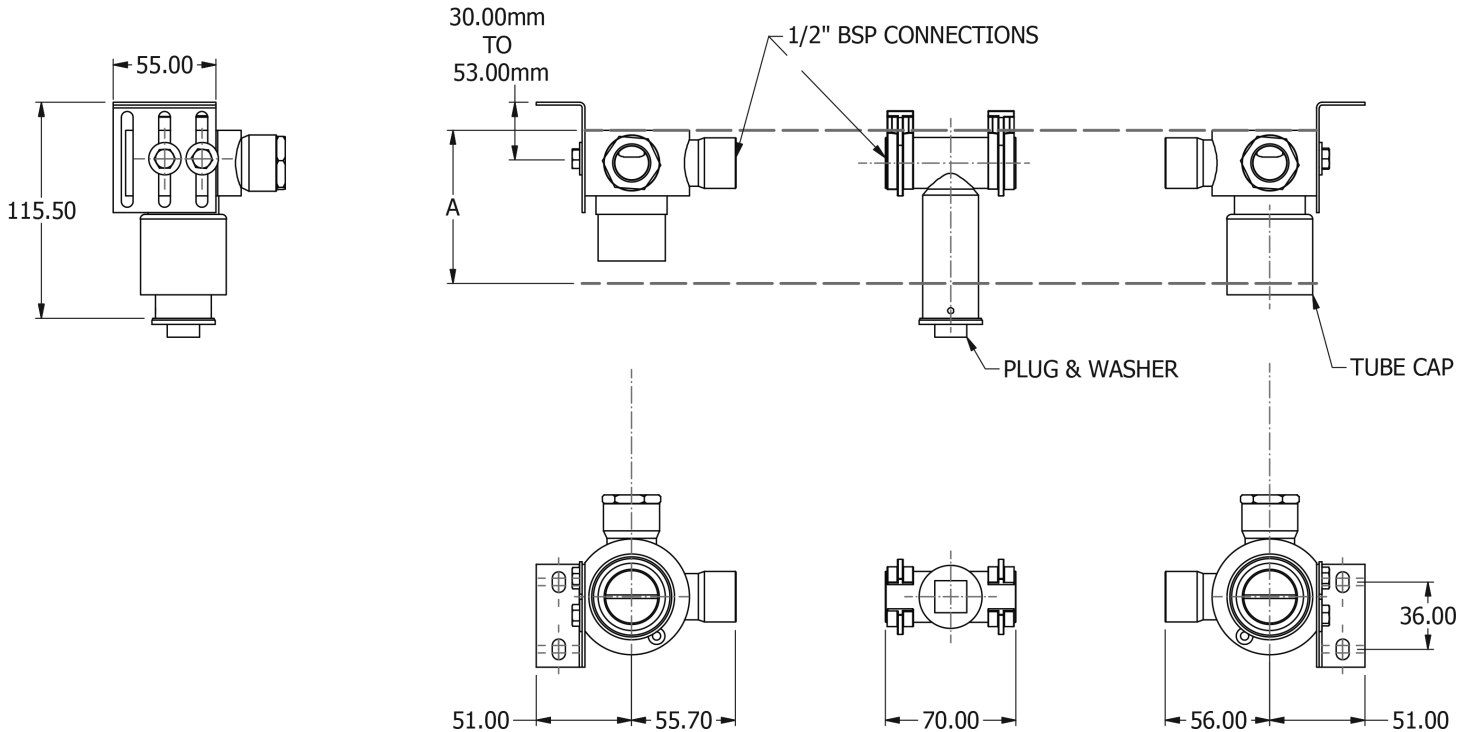

UK Customer Service
 Leopold Street
 Birmingham
 B12 0UJ
 Tel: +44 121 766 4200
 Email: info@samuel-heath.com

US Customer Service
 Federal I.D. No. 58-1504682
 Email: usa@samuel-heath.com

Specification Enquiries
 Design Centre Chelsea Harbour
 1st Floor, North Dome, London
 SW10 0XE
 Tel: 020 7352 0249
 Email: showroom@samuel-heath.com

1-19/09/2023